

METRIC OEM SERIES TRD-J

INCREMENT SHAFT ENCODER

OUTSIDE DIMENSIONS

● With side cable

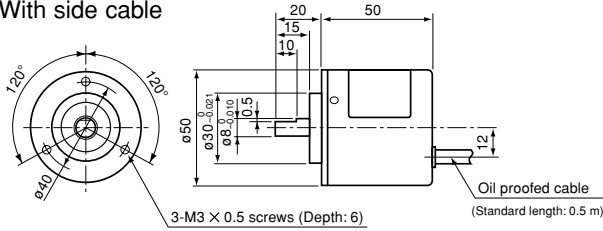

WIRING DIAGRAM (Shield ≠ Body) AWG 20-22

One-phase: TRD-JXXX-S

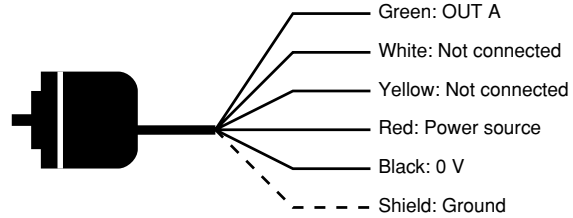

TTL (Totem Pole) Wave Form CW (Viewed from the encoder shaft)

One-phase: TRD-JXXX-S

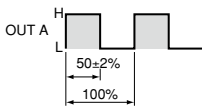

Two-phase with Index: TRD-JXXX-RZ

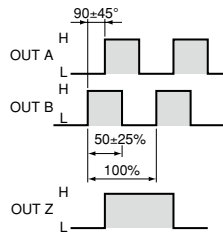

Two-phase with Index: AWG 20-22

TRD-JXXX-RZ

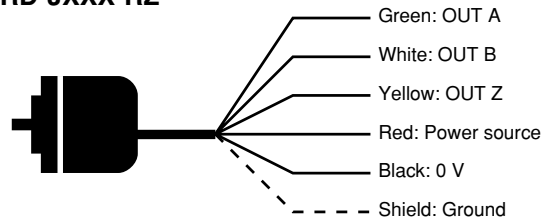

TTL OUTPUT circuit

Totem-pole output:

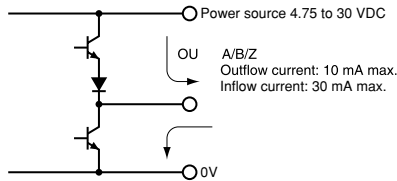

BELL FLANGES / For Servo / Round Flange Encoder

NEMA 42-Flat Bottom	F-20	\$60.00
NEMA 42-Pilot@Bottom	F-21	\$60.00

F-21

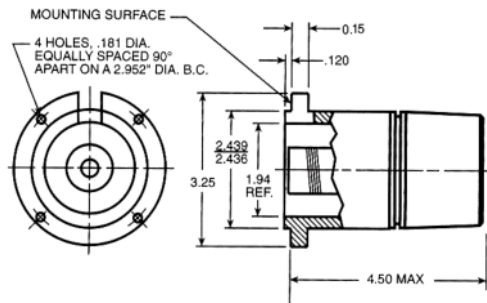

F-20

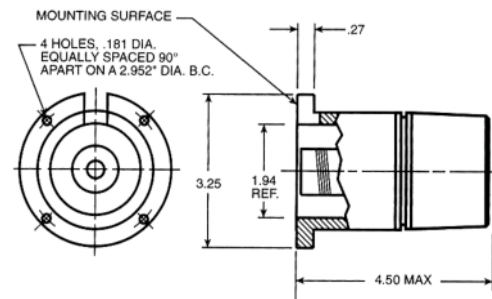

OPTIONAL PARTS: Order Separately

FLEXIBLE COUPLING

BT075-C.250-P8MM	\$80.00
BT100-C.375-P8MM	\$90.00
BT125-C.375-P8MM	\$100.00

(Refer to Page 20 for the detail specifications.)

35mm CENTER HEIGHT FOOT MOUNTING BRACKET

65mmHx65mmWx45mmL	JT-035	\$16.00
-------------------	--------	---------



12" CIRCUMFERENCE MEASURING WHEEL (3.82" dia)

Material	Hub x Width	Part No.	Price
Urethane	8mm x 3/8"	MW-1-8MM	\$45.00
Urethane	8mm x 1"	MW-1W-8MM	\$50.00

Urethane Rubber: 83A Shore Hardness
Operating Temperature: -25° to 65° C, -20° to 150° F